

Pearson BTEC Level 5 Higher Nationals in Engineering (RQF)

Unit 52: Further Electrical, Electronic and Digital Principles

Unit Workbook 4

in a series of 4 for this unit

Learning Outcome 4

Non-linear Circuits

Contents

INTRODUCTION	3
Linear Circuits.....	3
Non-linear Circuits	4
Diode Theory.....	5
P-N Junction Diode.....	5
Depletion Layer	5
Barrier Potential.....	6
Connecting a Voltage to a Diode.....	6
Forward Bias.....	7
Reverse Bias	7
Diode Characteristics	8
Zener Diode.....	9
Light Emitting Diode - LED.....	10
Mathematical Modelling of a Diode	13
Bipolar Junction Transistor (BJT) Theory.....	15
Bipolar Junction Transistor	15
NPN Transistor Biasing.....	18
Input Characteristic.....	19
Output Characteristic.....	19
Transfer Characteristic.....	20
Transistor as a Switch.....	21
Voltage Amplifier	23
Mathematical Modelling of a Bipolar Junction Transistor.....	24
Field Effect Transistor (FET) Theory	28
Junction Field Effect Transistor (JFET).....	28
MOSFETs.....	29
Common Source Voltage Amplifier Circuit	31
Mathematical Modelling of a Field Effect Transistor.....	32

INTRODUCTION

Linear Circuits

A linear circuit is one where the circuit parameters are unchanged by varying voltage or current (or frequency). For example, if a varying voltage is applied to a resistor then the current through the resistor will be directly proportional to the applied voltage, but the actual resistance of the resistor is unchanged by the application of the changing voltage or consequent changing current. Consider Ohm's Law ...

$$I = \frac{V}{R} \quad [A]$$

This can be re-written as ...

$$I = \left(\frac{1}{R}\right)V \quad [A]$$

You will remember the equation of a straight line from your school days ...

$$y = mx + c$$

y is the vertical quantity (the dependent variable – it depends on the independent variable x)

m is the slope – change in vertical divided by change in horizontal

x is the independent variable

c is the point on the y axis where the graph intersects

So, for our simple resistor circuit, we could write ...

$$I = \left(\frac{1}{R}\right)V + 0 \quad [A]$$

$1/R$ is the slope – equivalent to m

V is our independent variable – equivalent to x

0 is the point where the graph crosses the vertical I axis

We therefore have a linear relationship between current and voltage in the case of a resistor.

Inductors and capacitors are also linear devices (at least in their ideal form). Their inductance or capacitance is unchanged by voltage, current or frequency.

Non-linear Circuits

Non-linear circuits are so-named because their resistance, inductance, capacitance, and even waveform shape is not constant.

Should we go to the extremes of frequency, even a resistor can be thought of as being non-linear, because a resistor will have tiny amounts of parasitic capacitance and inductance. At these extremes of frequency, we also see capacitors having parasitic inductance, and inductors having parasitic capacitance, but these considerations are beyond the scope of our present studies.

For our current purposes, we consider non-linear circuits as those which contain semiconductor devices, such as diodes, bipolar junction transistors (BJTs) and field-effect transistors (FETs). The main reason why these devices are considered non-linear is that their functionality is based upon complex physics and transit of electrical charges, dependent upon factors like current, voltage, temperature and frequency.

Diode Theory

P-N Junction Diode

A simple semiconductor device is the diode. This consists of a region of p-type semiconductor alongside a region of n-type semiconductor. A silicon diode is formed from one complete crystal of silicon with the impurities infused into it to make it part n-type and part p-type. A junction exists at the boundary between the n-type and p-type silicon.

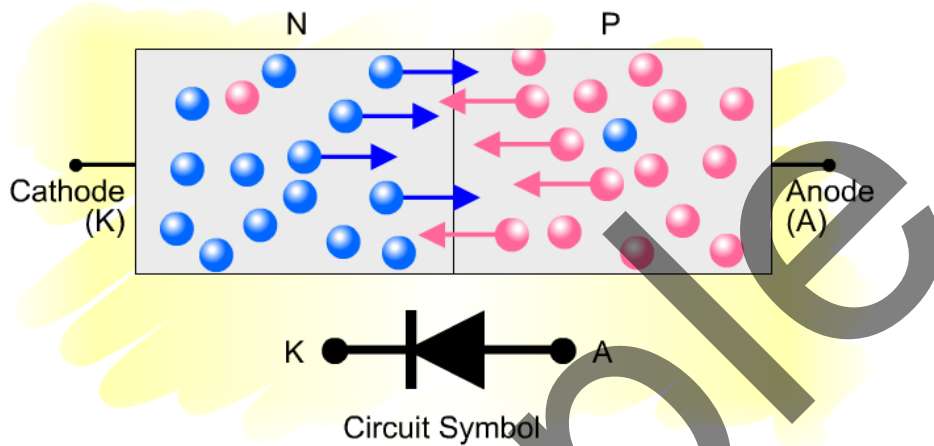

Depletion Layer

When the p-n junction is manufactured some of the free electrons in the n-type material will cross the junction and fill the holes in the p-type material.

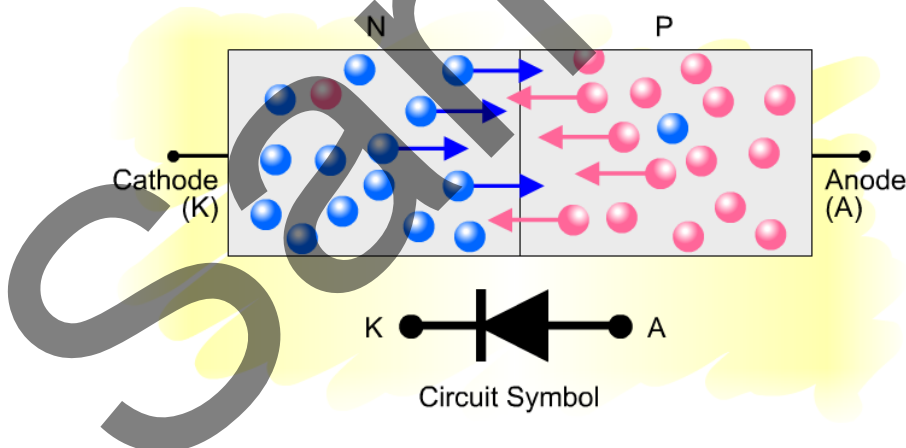

Where these electrons fill the holes, a region will be created containing no free electrons. With no free electrons this region becomes an insulator. This region is called the **depletion layer** as it is depleted of free electrons.

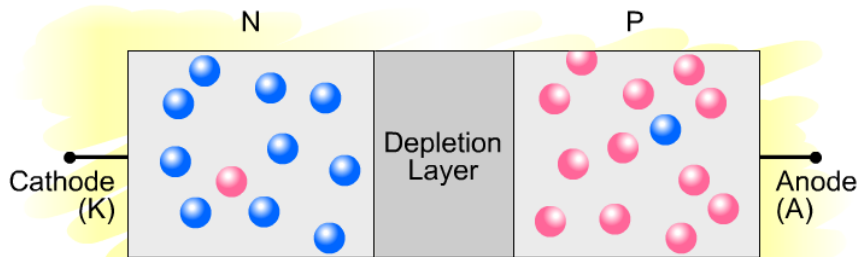

Barrier Potential

In the p-type region the increase in the number of electrons will cause a negative charge to build up as there will be more electrons than protons. This negative charge will repel electrons, so preventing more electrons crossing the junction.

Where electrons have moved from the n-type region, the atoms will have an overall positive charge since these atoms will have fewer negative electrons than positive protons. This will cause a positive charge to build up in the n-type region.

The charge that builds up to stop electrons from crossing the junction is called the **barrier potential**.

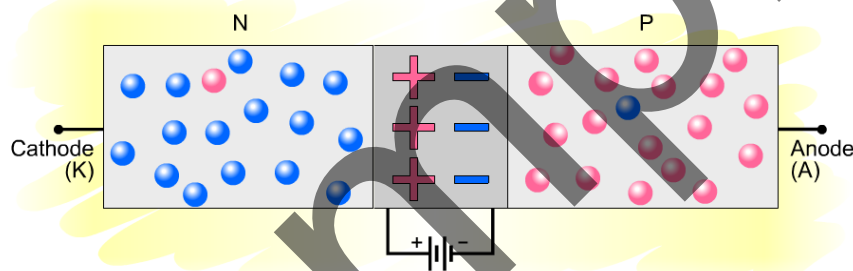

Connecting a Voltage to a Diode

Consider a voltage connected across the diode such that the positive voltage is applied to the p-type region and the negative voltage is applied to the n-type region. The positive voltage will repel the holes in the p-type material pushing them towards the junction. The negative voltage will repel the electrons in the n-type material also pushing them towards the junction.

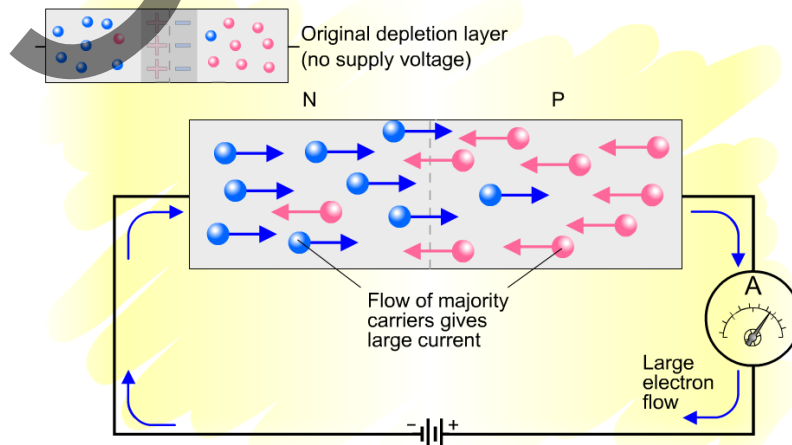

Forward Bias

If the applied voltage is large enough the depletion layer will totally collapse. Electrons from the negative terminal of the power supply will now be able to enter the diode, cross the junction, and continue round the circuit to the positive terminal. A current will therefore be flowing in the circuit. When voltage is applied to a diode so that a current will flow, the diode is said to be **forward biased**.

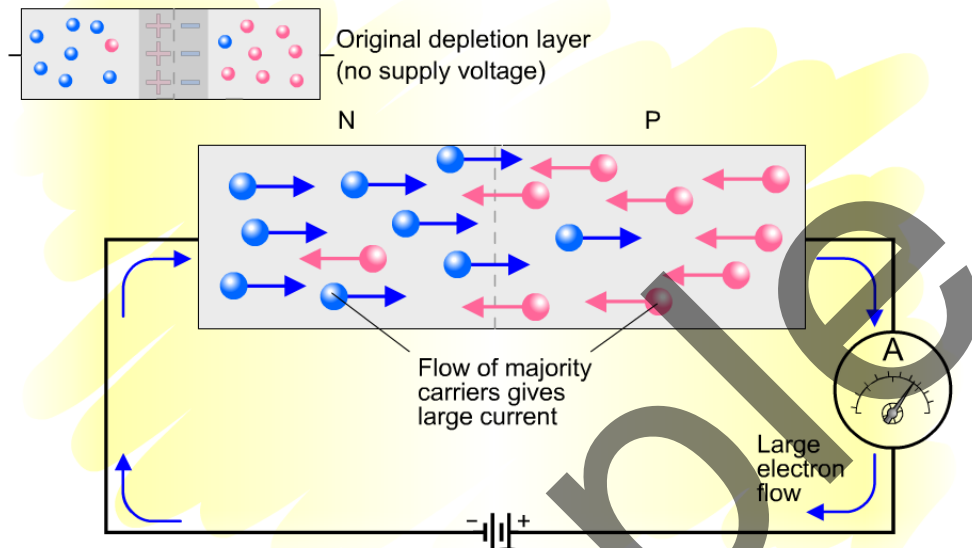

Reverse Bias

When voltage is applied to a diode so that a current does not flow the diode is said to be **reverse biased**. A very small current will actually flow when the diode is reverse biased caused by a small number of electrons that will still be found in the depletion layer, being pushed across the junction. This small current is called the **leakage current** and often is so small it cannot be measured with ordinary meters.

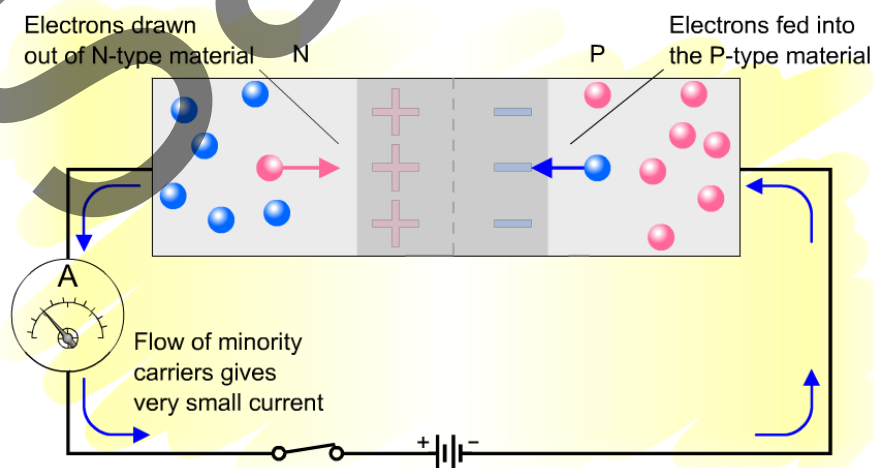

Diode Characteristics

A diode is a semiconductor device that will conduct well in one direction, but stop current flow in the other. The I-V characteristic curve for a diode shows how the current flowing in a diode is dependent upon the voltage that is applied across it.

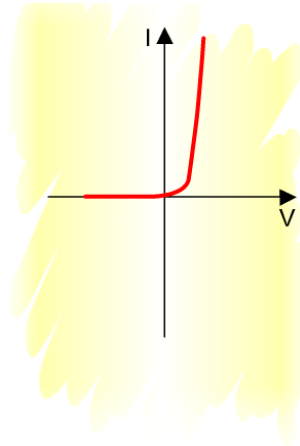

When forward biased, the diode will conduct well and allow a current to pass. When reverse biased, the diode does not conduct and will stop current flowing.

By examining the I-V characteristic curve, it can be seen that the diode doesn't fully conduct straight away when a forward biased voltage is applied across it. Before a diode can fully conduct, the depletion layer must be removed by applying a voltage across the diode. For a silicon diode, typically 0.6V must be applied across the diode before it will conduct.

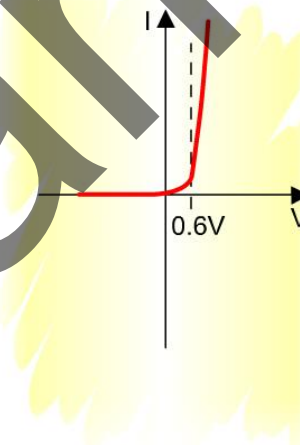

When a diode is reverse biased, a very small current will flow, typically only a few microamps. However, if the reverse bias voltage is sufficiently large, the current will suddenly rapidly increase. At this point, a large number of the outer electrons that were strongly bonded together, gain enough energy to break free. This point is called the **reverse breakdown point**. It is also called the **avalanche voltage**. The value of the avalanche voltage depends on how the diode was manufactured. To prevent damage, a diode must be selected so that the reverse voltage never exceeds this value.

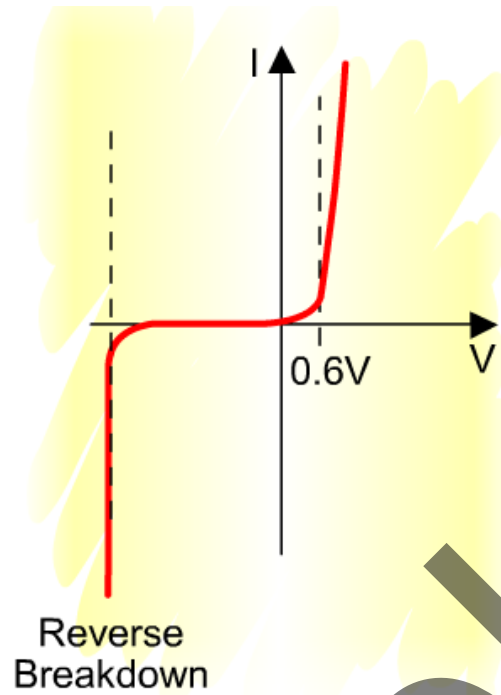

Diode Symbol

A diode is represented by the following symbol.



The diode will be forward biased when the anode is more positive in respect to the cathode. The cathode on a diode is often marked as shown.



Zener Diode

A **zener diode** is a special type of diode that can be used to regulate a voltage. The symbol for a zener diode has a bent bar to indicate the cathode.

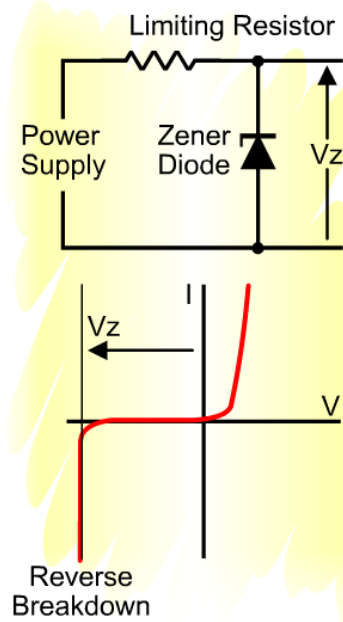

Unlike a standard diode, a zener diode is operated in reverse breakdown mode, with current flowing from cathode to anode.

Light Emitting Diode - LED

A special type of diode is the Light Emitting Diode (LED). This diode will emit light when it is forward biased. When reverse biased no current will flow, therefore no light will be emitted. The symbol for an LED is a diode symbol with arrows coming off it to indicate that it emits light.

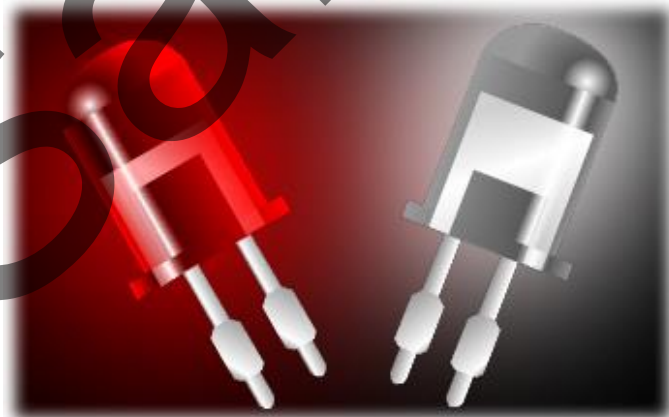

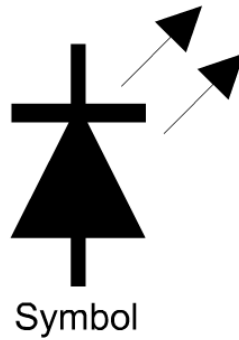

When electrons jump across the junction between the n-type and p-type material to combine with a hole, their energy level changes. In a silicon diode, this energy is converted to heat, but some materials, such as Gallium Arsenide (GaAs), will convert this energy to heat and also to light. Depending on the material used, LEDs that emit red, green, yellow and blue light can be manufactured.

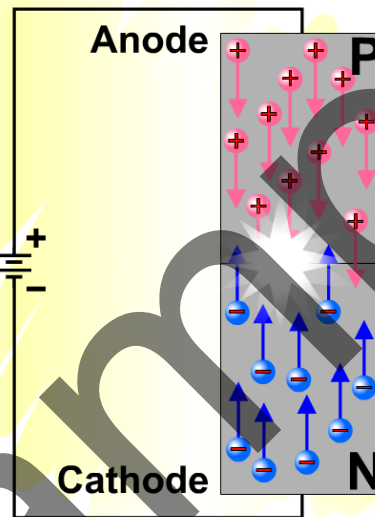

The I-V characteristic for an LED is similar to a standard diode. It can be seen that LEDs require a higher switch-on voltage than ordinary silicon diodes. From the I-V characteristic curve shown, it can be seen that red LEDs are the most efficient, requiring the lowest switch-on voltage. Typically the forward bias voltage required to switch on an LED is about 2V. This compares with about 0.6V for an ordinary silicon diode.